

BĂNG

ĐIỂM

COLLECTION

FACT SHEET

Điểm table lamp

By Thomas Vincent for BÀNG

A collection of accessories, furniture and lighting. Using the fewest possible metal sheets in the making process, the final products take sleek and monolithic shapes. Combined with a square hole matrix, what remains is an aesthetic defined by what's already gone. In Vietnamese, điểm means point/dot.

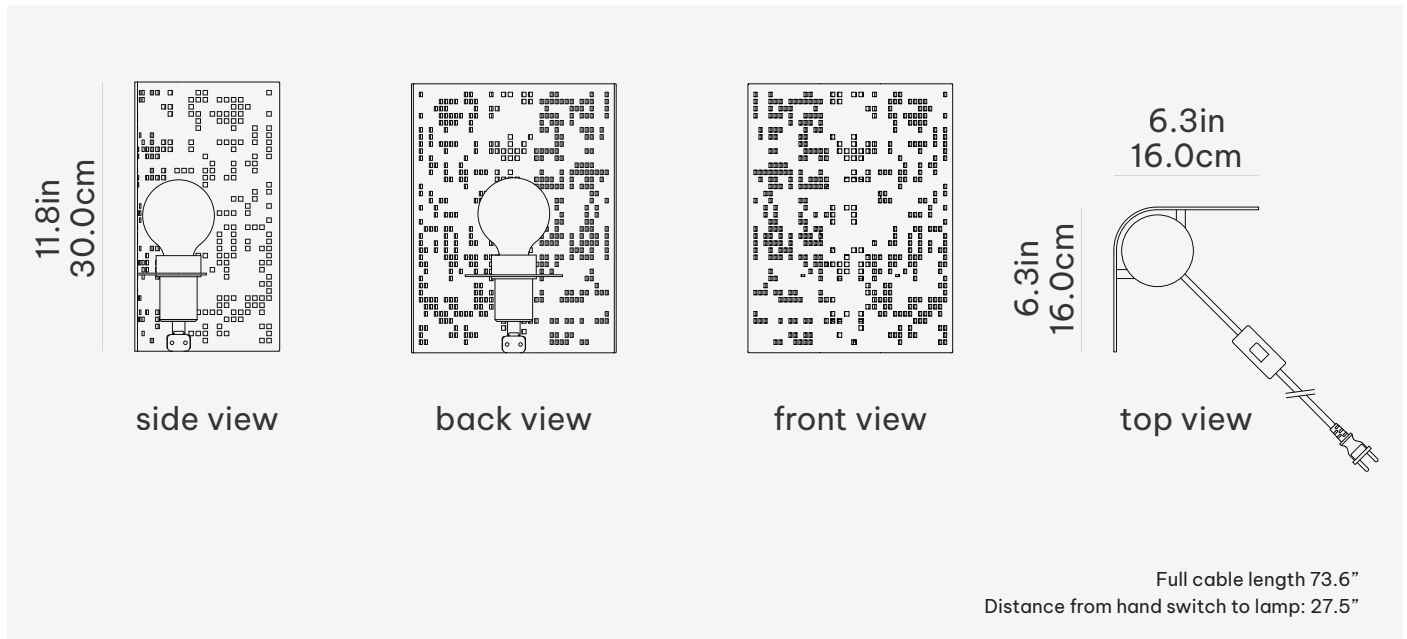
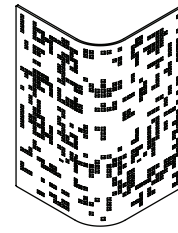

Name	Điểm table lamp
Size	Small
SKU	MT0246-NRTL
Dimensions	L6.3" x W6.3" x H11.8" inches
Materials	Steel aluminum
Finish	Cream or Black powder coating, or Raw steel
Light bulb	E26 G80 LED (not included)
Cable length	73.6" inches
Switch	in-line on/off hand switch
Plug	Polarized two pins, type A
Certifications	UL 153 CSA C22.2 No. 250.4
Net weight	5.3 lbs
Gross weight	5.7 lbs
Packaging	L7.3" x W7.3" x H13.2" inches
Country of origin	Vietnam

Cream and black powder coating
(offers uniform, solid and anti-corrosive finishes)

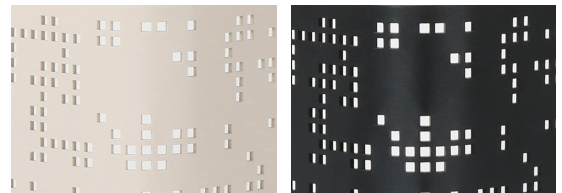

The raw steel finish is a signature of BÀNG. Once our products are crafted, they are simply varnished without any anti-corrosive treatment. Over time, the finish will naturally evolve with its environment. This gradual oxidation process ensures that each piece becomes unique and full of character.

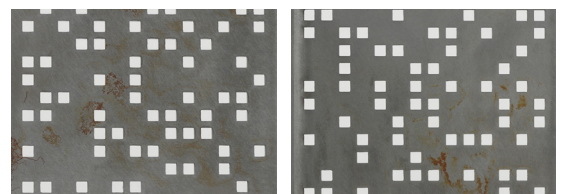
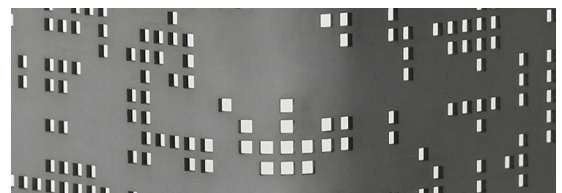

Điểm book-end

By Thomas Vincent for BằNG

A collection of accessories, furniture and lighting. Using the fewest possible metal sheets in the making process, the final products take sleek and monolithic shapes. Combined with a square hole matrix, what remains is an aesthetic defined by what's already gone. In Vietnamese, điểm means point/dot.

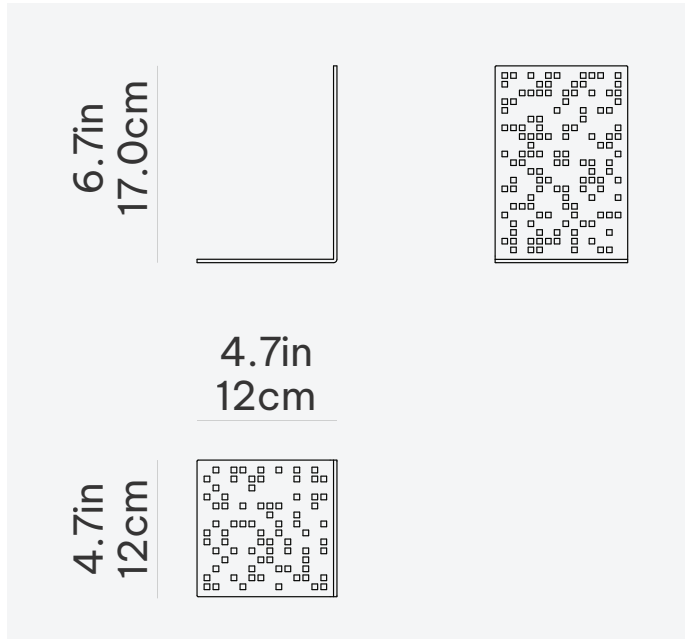
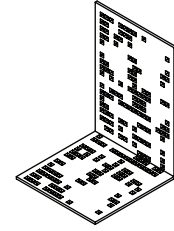

Name	Điểm book-end
Size	Small
SKU	MA0173
Dimensions	L4.7" x W4.7" x H6.7" inches
Materials	Steel
Finish	Cream or Black powder coating, or Raw steel
Net weight	1.8 lbs
Gross weight	2.2 lbs
Packaging	L5.5" x W5.5" x H8.5" inches
Country of origin	Vietnam

Cream and black powder coating
(offers uniform, solid and anti-corrosive finishes)

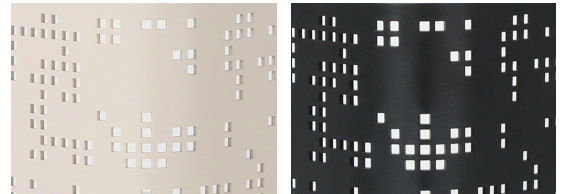

The raw steel finish is a signature of BằNG. Once our products are crafted, they are simply varnished without any anti-corrosive treatment. Over time, the finish will naturally evolve with its environment. This gradual oxidation process ensures that each piece becomes unique and full of character.

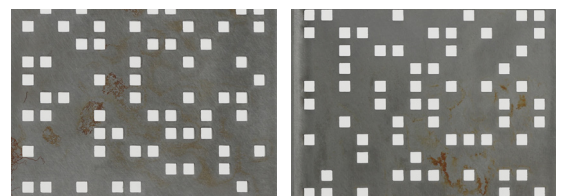
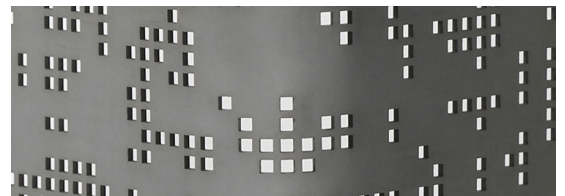

Điểm pot

By Thomas Vincent for BằNG

A collection of accessories, furniture and lighting. Using the fewest possible metal sheets in the making process, the final products take sleek and monolithic shapes. Combined with a square hole matrix, what remains is an aesthetic defined by what's already gone. In Vietnamese, *điểm* means point/dot.

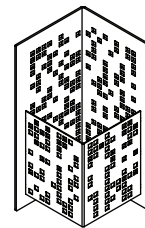

Name	Điểm pot
Size	Small
SKU	MA0174
Dimensions	L3.7" x W3.7" x H7.9" inches
Materials	Steel
Finish	Cream or Black powder coating, or Raw steel
Net weight	1.8 lbs
Gross weight	2.4 lbs
Packaging	L4.5" x W4.5" x H9.3" inches
Country of origin	Vietnam

Cream and black powder coating
(offers uniform, solid and anti-corrosive finishes)

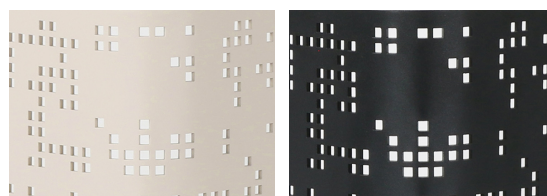

The raw steel finish is a signature of BằNG. Once our products are crafted, they are simply varnished without any anti-corrosive treatment. Over time, the finish will naturally evolve with its environment. This gradual oxidation process ensures that each piece becomes unique and full of character.

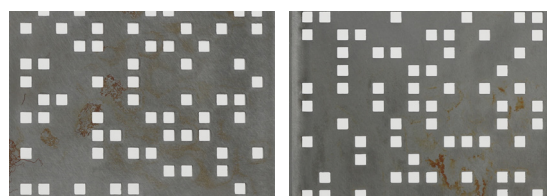
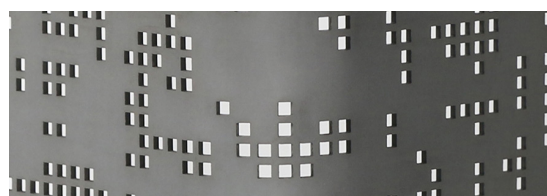

Điểm edge table

By Thomas Vincent for BÀNG

A collection of accessories, furniture and lighting. Using the fewest possible metal sheets in the making process, the final products take sleek and monolithic shapes. Combined with a square hole matrix, what remains is an aesthetic defined by what's already gone. In Vietnamese, điểm means point/dot.

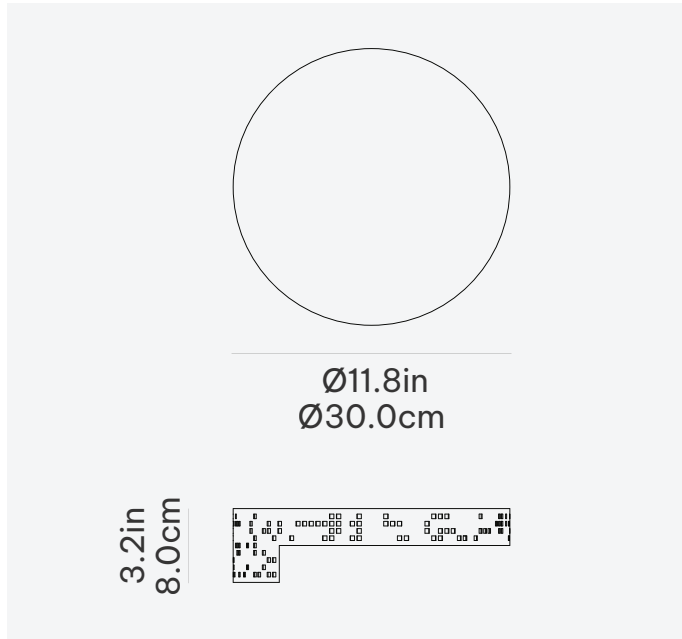
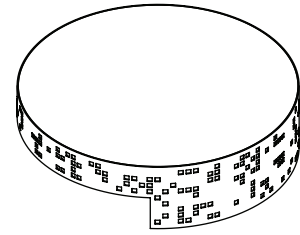

Name	Điểm edge table
Size	Small
SKU	MA0175
Dimensions	Ø11.8" x H3.2" inches
Materials	Steel
Finish	Cream or Black powder coating, or Raw steel
Net weight	2.9 lbs
Gross weight	4.9 lbs
Packaging	L13.4" x W13.4" x H5.9" inches
Country of origin	Vietnam

Cream and black powder coating
(offers uniform, solid and anti-corrosive finishes)

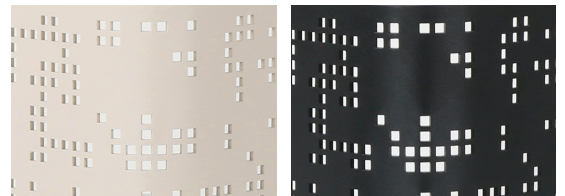

The raw steel finish is a signature of BÀNG. Once our products are crafted, they are simply varnished without any anti-corrosive treatment. Over time, the finish will naturally evolve with its environment. This gradual oxidation process ensures that each piece becomes unique and full of character.

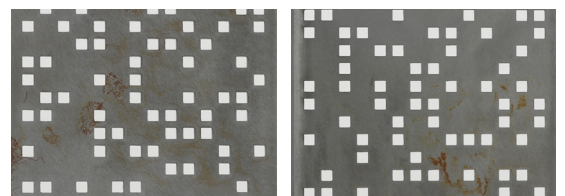
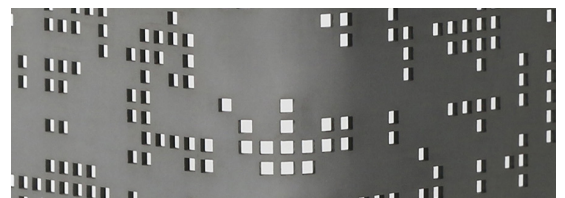

Điểm stool

By Thomas Vincent for BằNG

A collection of accessories, furniture and lighting. Using the fewest possible metal sheets in the making process, the final products take sleek and monolithic shapes. Combined with a square hole matrix, what remains is an aesthetic defined by what's already gone. In Vietnamese, điểm means point/dot.

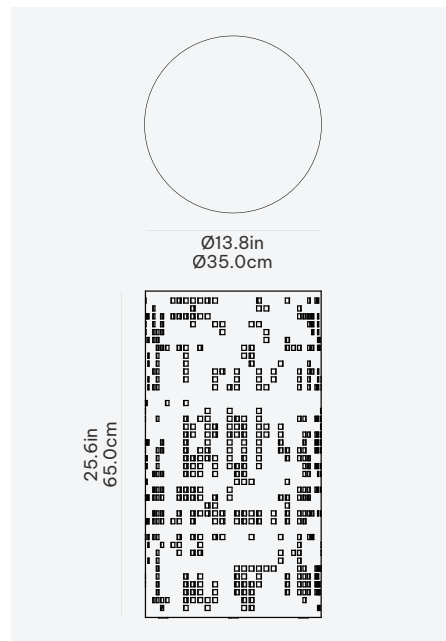
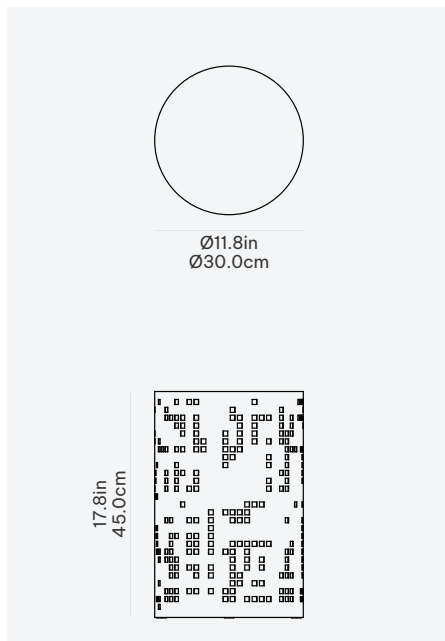
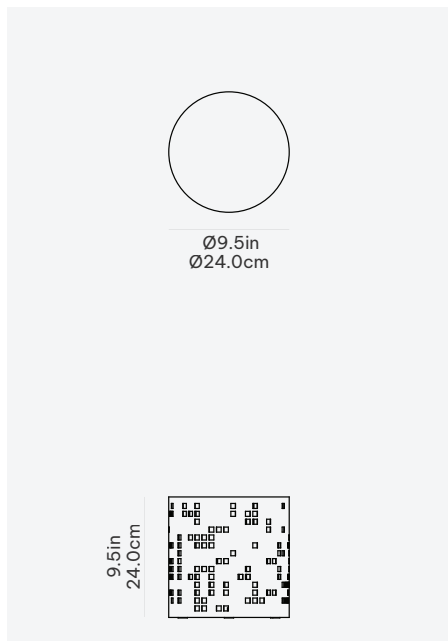
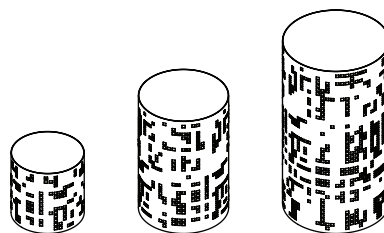

Name	Điểm stool
Size	Small
SKU	MFR0169
Dimensions	Ø9.45" x H9.45" inches
Materials	Steel
Finish	Cream or Black powder coating, or Raw steel
Net weight	5.3 lbs
Gross weight	8.8 lbs
Packaging	L10.8" x W10.8" x H12.2" inches
Country of origin	Vietnam
Note	Adjustable leg pads included

Name	Điểm stool
Size	Medium
SKU	MFR0210
Dimensions	Ø11.81" x 17.72" inches
Materials	Steel
Finish	Cream or Black powder coating, or Raw steel
Net weight	11 lbs
Gross weight	16.5 lbs
Packaging	L13.4" x W13.4" x H20.3" inches
Country of origin	Vietnam
Note	Adjustable leg pads included

Name	Điểm stool
Size	Large
SKU	MFR0170
Dimensions	Ø13.78" x H25.59" inches
Materials	Steel
Finish	Cream or Black powder coating, or Raw steel
Net weight	16.5 lbs
Gross weight	24.3 lbs
Packaging	L15.4" x W15.4" x H28.1" inches
Country of origin	Vietnam
Note	Adjustable leg pads included

Cream and black powder coating (offers uniform, solid and anti-corrosive finishes)



The raw steel finish is a signature of BằNG. Once our products are crafted, they are simply varnished without any anti-corrosive treatment. Over time, the finish will naturally evolve with its environment. This gradual oxidation process ensures that each piece becomes unique and full of character.

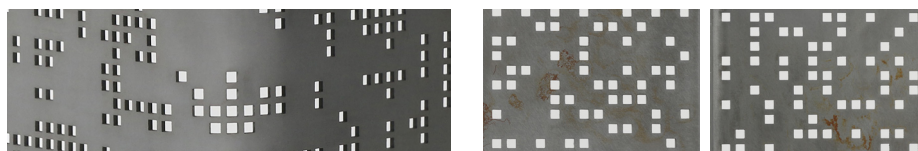

For more information, visit www.bangoibanga.com

Điểm round tables

By Thomas Vincent for BằNG

A collection of accessories, furniture and lighting. Using the fewest possible metal sheets in the making process, the final products take sleek and monolithic shapes. Combined with a square hole matrix, what remains is an aesthetic defined by what's already gone. In Vietnamese, điểm means point/dot.

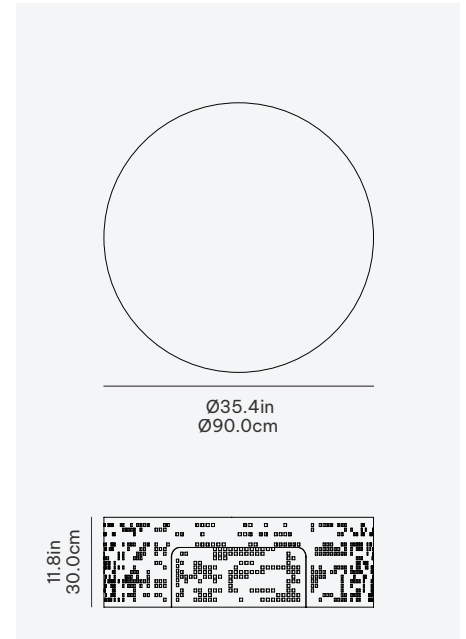
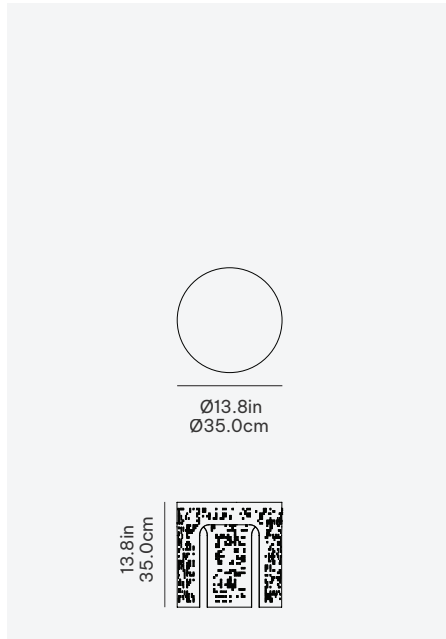
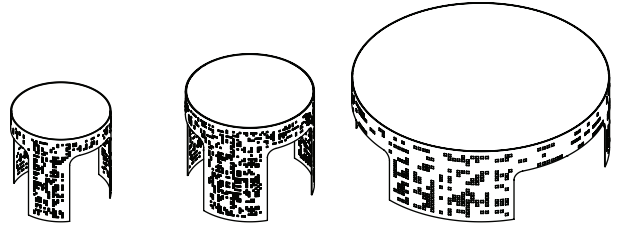

Name	Điểm round table
Size	Small
SKU	MFR0153
Dimensions	Ø13.8" x H13.8" inches
Materials	Steel, tempered glass
Finish	Cream or Black powder coating, or Raw steel
Net weight	12.3 lbs
Gross weight	19.2 lbs
Packaging	L15.2" x W15.2" x H18.5" inches
Country of origin	Vietnam
Note	Protection for table legs edges included

Name	Điểm round table
Size	Medium
SKU	MFR0152
Dimensions	Ø17.7" x H15.8" inches
Materials	Steel, tempered glass
Finish	Cream or Black powder coating, or Raw steel
Net weight	20.3 lbs
Gross weight	30.9 lbs
Packaging	L19.1" x W19.1" x H20.5" inches
Country of origin	Vietnam
Note	Protection for table legs edges included

Name	Điểm round table
Size	Large
SKU	MFR0151
Dimensions	Ø35.4" x H11.8" inches
Materials	Steel, tempered glass
Finish	Cream or Black powder coating, or Raw steel
Net weight	59.5 lbs
Gross weight	77.2 lbs
Packaging	L37" x W37" x H16.7" inches
Country of origin	Vietnam
Note	Protection for table legs edges included

Cream and black powder coating (offers uniform, solid and anti-corrosive finishes)

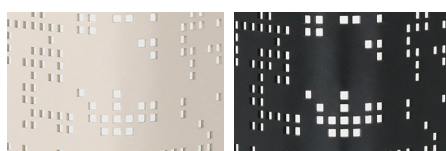

The raw steel finish is a signature of BằNG. Once our products are crafted, they are simply varnished without any anti-corrosive treatment. Over time, the finish will naturally evolve with its environment. This gradual oxidation process ensures that each piece becomes unique and full of character.

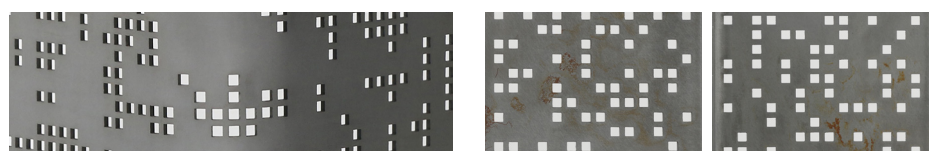

For more information, visit www.bangoibanga.com

Điểm wall mirror

By Thomas Vincent for BằNG

A collection of accessories, furniture and lighting. Using the fewest possible metal sheets in the making process, the final products take sleek and monolithic shapes. Combined with a square hole matrix, what remains is an aesthetic defined by what's already gone. In Vietnamese, điểm means point/dot.

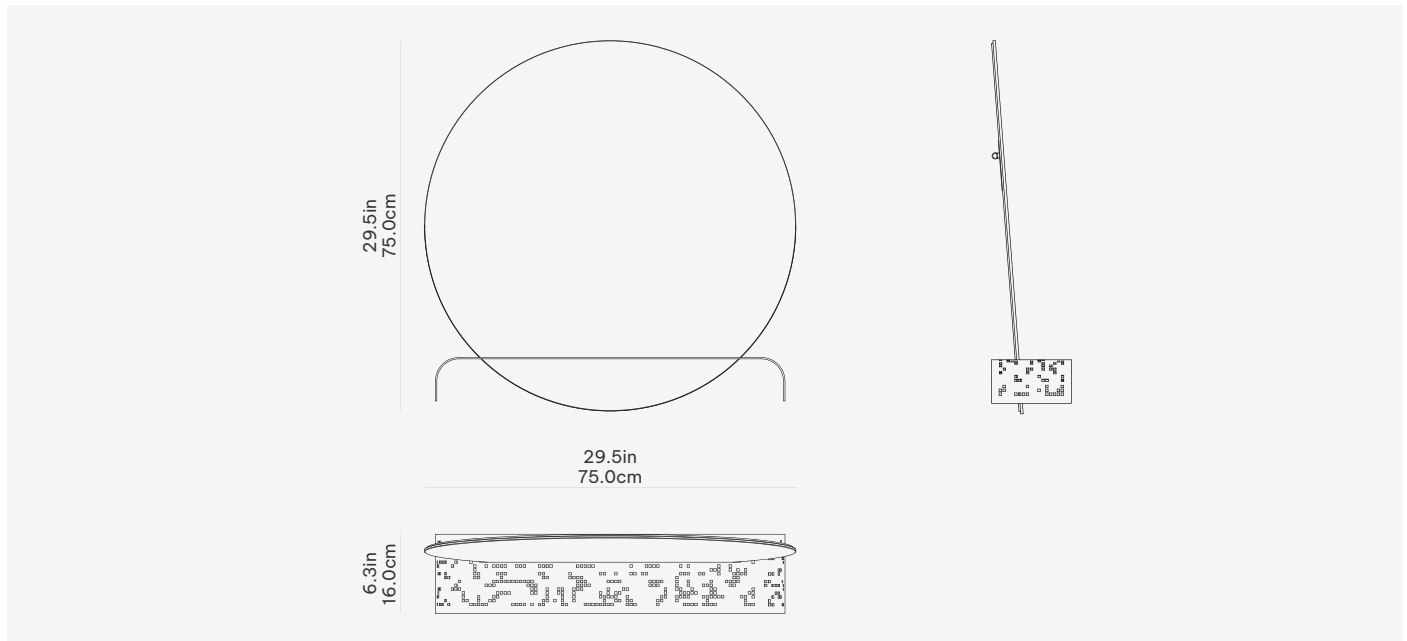
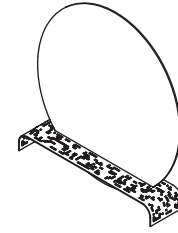

Name	Điểm round wall mirror
Size	Small
SKU	GFR0185
Dimensions	L29.5" x D6.3" x H29.5" inches
Materials	Steel, mirror, MDF
Finish	Cream or Black powder coating, or Raw steel
Net weight	20.9 lbs
Gross weight	28.9 lbs
Packaging	L31.7" x W31.7" x H3.2" inches,
Packaging	L29.3" x W7.9" x H4.9" inches
Country of origin	Vietnam
Note	Screw fixation to wall required, installation kit included, wall anchor included, max loading 3kg, mirror 5mm

Cream and black powder coating
(offers uniform, solid and anti-corrosive finishes)

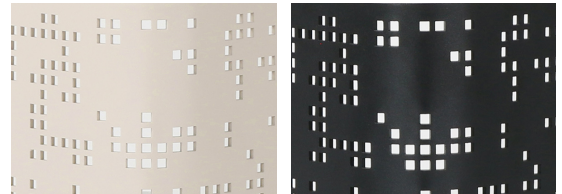

The raw steel finish is a signature of BằNG. Once our products are crafted, they are simply varnished without any anti-corrosive treatment. Over time, the finish will naturally evolve with its environment. This gradual oxidation process ensures that each piece becomes unique and full of character.

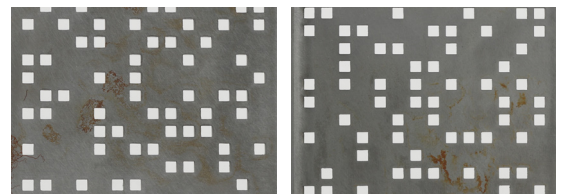
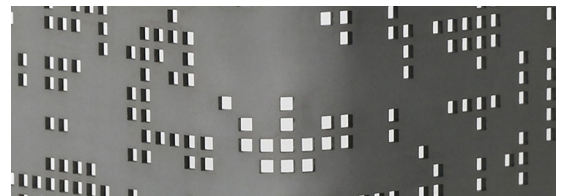

Điểm console table

By Thomas Vincent for BằNG

A collection of accessories, furniture and lighting. Using the fewest possible metal sheets in the making process, the final products take sleek and monolithic shapes. Combined with a square hole matrix, what remains is an aesthetic defined by what's already gone. In Vietnamese, điểm means point/dot.

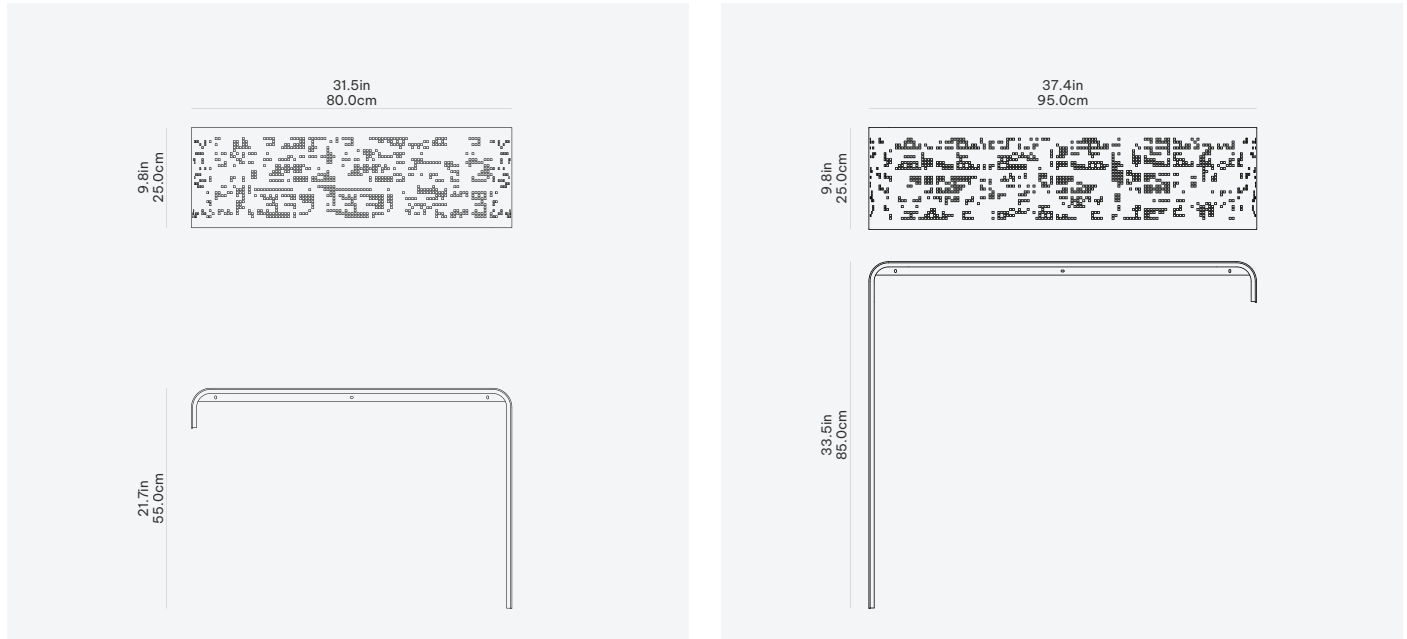
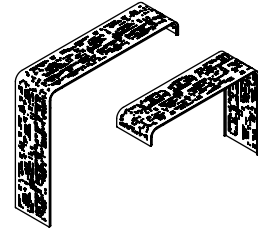

Name	Điểm console
Size	Small
SKU	MFR0164
Dimensions	L31.5" x W9.8" x H21.7" inches
Materials	Steel
Finish	Cream or Black powder coating, or Raw steel
Net weight	19.8 lbs
Gross weight	30.9 lbs
Packaging	L32.7" x W22.8" x H11" inches
Country of origin	Vietnam
Note	Fixation to wall required, Installation kit included Max loading 10kg

Name	Điểm console
Size	Large
SKU	MFR0163
Dimensions	L37.4" x W9.8" x H33.5" inches
Materials	Steel
Finish	Cream or Black powder coating, or Raw steel
Net weight	26.5 lbs
Gross weight	37.5 lbs
Packaging	L38.6" x W35" x H11" inches
Country of origin	Vietnam
Note	Fixation to wall required, Installation kit included Max loading 10kg

Cream and black powder coating (offers uniform, solid and anti-corrosive finishes)



The raw steel finish is a signature of BằNG. Once our products are crafted, they are simply varnished without any anti-corrosive treatment. Over time, the finish will naturally evolve with its environment. This gradual oxidation process ensures that each piece becomes unique and full of character.

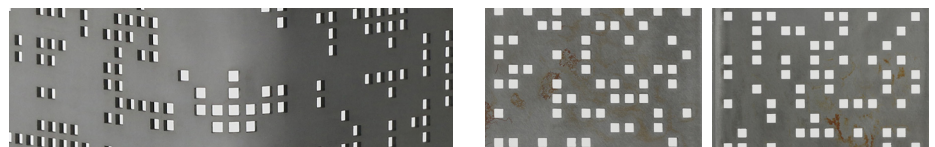

For more information, visit www.bangoibanga.com

Điểm nesting coffee table

By Thomas Vincent for BÀNG

A collection of accessories, furniture and lighting. Using the fewest possible metal sheets in the making process, the final products take sleek and monolithic shapes. Combined with a square hole matrix, what remains is an aesthetic defined by what's already gone. In Vietnamese, điểm means point/dot.

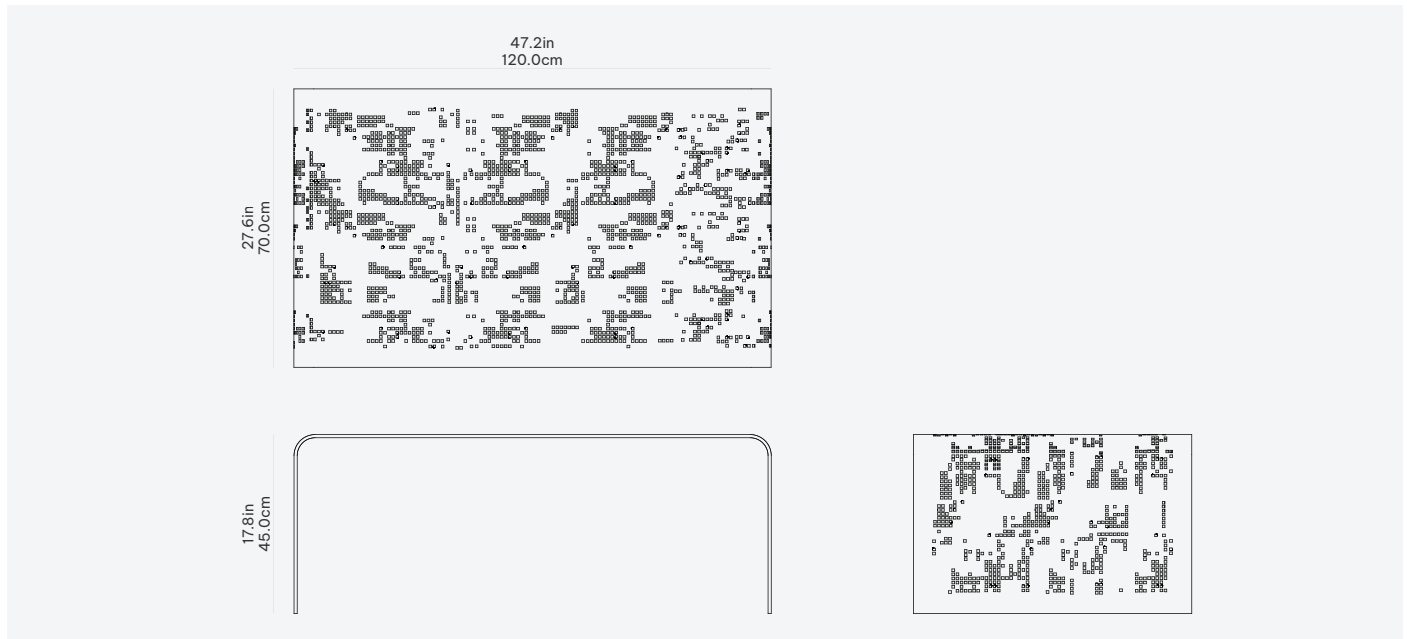
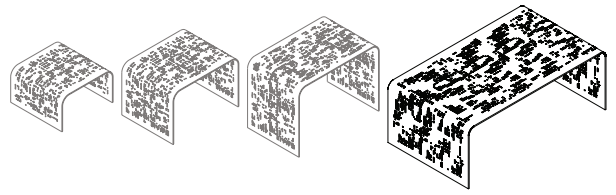

Name	Điểm nesting coffee table
SKU	MFR0154
Dimensions	L47.2" x W27.6" x H17.7" inches
Materials	Steel
Finish	Cream or Black powder coating, or Raw steel
Net weight	179 lbs
Gross weight	198 lbs
Packaging	L49.2" x W29.1" x H19.3" inches
Country of origin	Vietnam
Note	Leg pads included

Cream and black powder coating
(offers uniform, solid and anti-corrosive finishes)

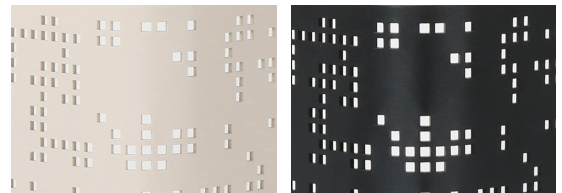

The raw steel finish is a signature of BÀNG. Once our products are crafted, they are simply varnished without any anti-corrosive treatment. Over time, the finish will naturally evolve with its environment. This gradual oxidation process ensures that each piece becomes unique and full of character.

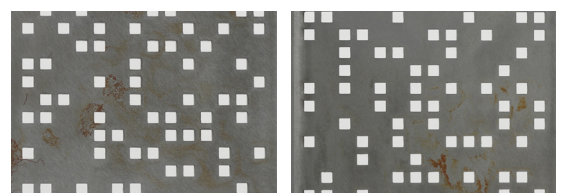
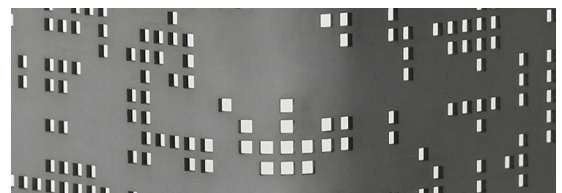

Điểm nesting side tables

By Thomas Vincent for BÀNG

A collection of accessories, furniture and lighting. Using the fewest possible metal sheets in the making process, the final products take sleek and monolithic shapes. Combined with a square hole matrix, what remains is an aesthetic defined by what's already gone. In Vietnamese, điểm means point/dot.

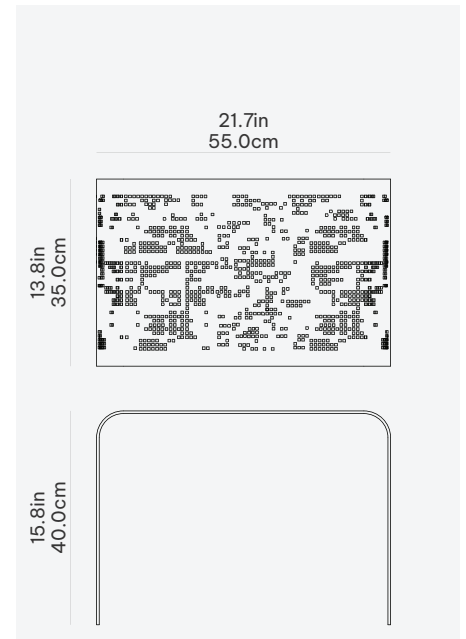
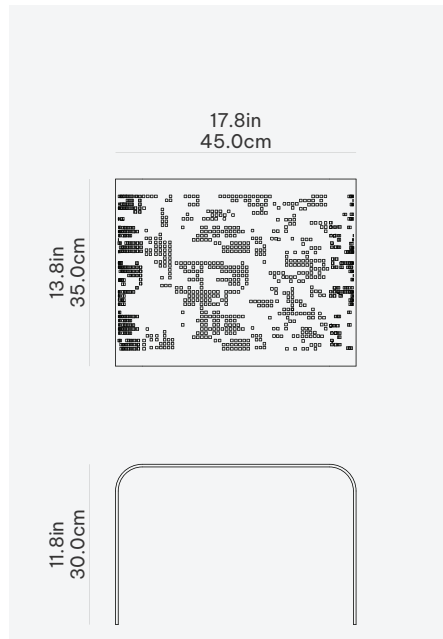
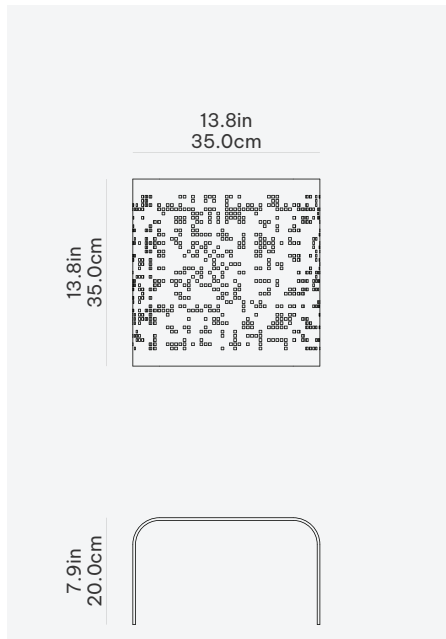
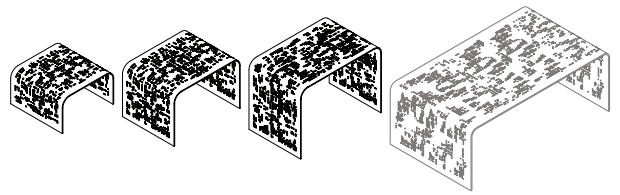

Name	Điểm nesting table
Size	Small
SKU	MFR0157
Dimensions	L13.8" x W13.8" x H7.9" inches
Materials	Steel
Finish	Cream or Black powder coating, or Raw steel
Net weight	19 lbs
Gross weight	24.3 lbs
Packaging	L15.7" x W15.9" x H10.4" inches
Country of origin	Vietnam
Note	Leg pads included

Name	Điểm nesting table
Size	Medium
SKU	MFR0156
Dimensions	L17.7" x W13.8" x H11.8" inches
Materials	Steel
Finish	Cream or Black powder coating, or Raw steel
Net weight	32 lbs
Gross weight	37.5 lbs
Packaging	L20.1" x W15.9" x H14.4" inches
Country of origin	Vietnam
Note	Leg pads included

Name	Điểm nesting table
Size	Large
SKU	MFR0155
Dimensions	L21.7" x W13.8" x H15.8" inches
Materials	Steel
Finish	Cream or Black powder coating, or Raw steel
Net weight	34.2 lbs
Gross weight	41.9 lbs
Packaging	L23.6" x W15.9" x H18.3" inches
Country of origin	Vietnam
Note	Leg pads included

Cream and black powder coating (offers uniform, solid and anti-corrosive finishes)

The raw steel finish is a signature of BÀNG. Once our products are crafted, they are simply varnished without any anti-corrosive treatment. Over time, the finish will naturally evolve with its environment. This gradual oxidation process ensures that each piece becomes unique and full of character.

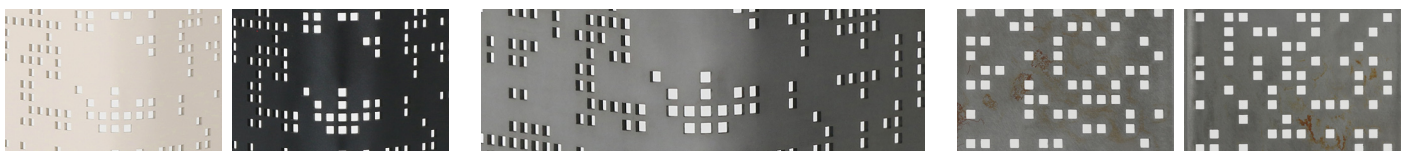

For more information, visit www.bangoibanga.com

**UNBORING
OBJECTS**

Bübing